

BENE ACTRON G

Water purification plants
for airports and big drainage areas

High performance separator
for highest environmental safety and
lowest operational costs



**BENE Environmental Technologies:
The company**

We specialize on separation technology. Thanks to our experience and necessary savvy we can offer our customers outright service:

- Planning service
- Manufacturing, delivery and installation of plants from NS 3 up to 2400 [l/s] (or 48 up to 38.000 gpm) and for special requirements of the customer also bigger plants
- Custom- made- separators;
Customer-oriented developments

Field of application

Separator system BENE ACTRON G has been especially adapted for big nominal sizes as alternative to RiStWag-plants. Upon draining such areas the waste water has to be treated before getting into waters to eliminate the danger of many sources of harmful substances.

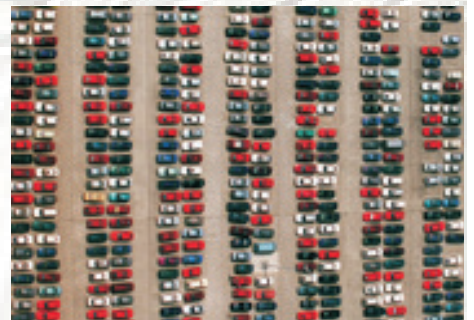

For operation and the necessary inspections of plants we can offer you also following services:

- Maintenance and inspection; spare parts
- Training, instructions, installation guidance
- Customer center (for the customer's questions concerning technology or advising)
- Optional non-binding free consultation on the site
- Planning and engineer center (Help with your concepts on waste water)

BENE ACTRON G can according to that be applied in all cases where extreme hydraulic performance is required:

- Production sites
- Big service and maintenance areas
- Municipal and military companies
- Industry and trade areas
- Public traffic areas
- Street areas e.g. in water protection areas
- Big bridges built for traffic



Components and plant equipment

BENE ACTRON G as modern system integrates in opposite to traditional technology all the following in one construction:

- Sludge trap
- Coalescence separator without filter
- Automatic oil separation
- Closed oil collection tank
- Sample taking device

Nominal sizes

BENE ACTRON G has no size limit; in general the plant will be adjusted to the hydraulic requirements.



**BENE ACTRON G:
A hydrodynamic separator**

In traditional systems the purification performance is strongly coupled and dependent on the degree of the contamination of filter, granulate or corrugated plates. Besides the traditional separators clog after short operation time what depends on the particular amount of inflowing dust, sludge and oil.



It can not happen with BENE ACTRON G!



Hydrodynamic coalescence

- Hydrodynamic roll with vertical and horizontal vector orientation cause regional liquid accumulation zones
- A three-dimension grid from accumulation and accumulation-free areas accrues in the separation area
- In accumulation zones finest disperse floating light liquid droplets meet together
- Coalescence processes lead to high purification grade under 5mg/l
- The purification performance of this systems is permanent on equally high level

With BENE the coalescence effect will be obtained thanks to an excellent and optimized idea. This patented principle achieves a permanently high purification grade without coalescence material.



The picture shows an example of separator (DIBt Z-54.8-350)

Advantages for the user

The BENE products convince with their high innovative technology and:

1. Easiness of maintenance
2. Technical robustness
3. Economic efficiency
4. Environmental safety
5. Operational safety

5. Operational safety

- Independent maintenance or disposal of single coalescence modules without shutdown
- Smallest amount of single modules
- Avoiding of channel clogging thanks to guaranteed stopping of suspended and floating matters
- Robust construction of swimmer closing (no movable parts like joints, etc.), which closes safely independent of the thickness of the light liquid
- Inflow closing for protection against raising up of oil
- Higher free consistency of liquid stream
→ in inflow and coalescence area: flow-through -NS- quotient 20 to 50 cm²/NS
→ in outflow area: already by regular operating (e.g. machine wash or minimum rain) flow through- NS- quotient 40- 90 cm²/NS
- Function parts are not prone to backdraft; no emergency disposal and shutdown of operating after the accumulation

3. Economic efficiency

- A perfectly developed unit assembly system causes definitely lower disposal costs; that is why higher costs of BENE ACTRON G system pay off after short operation time

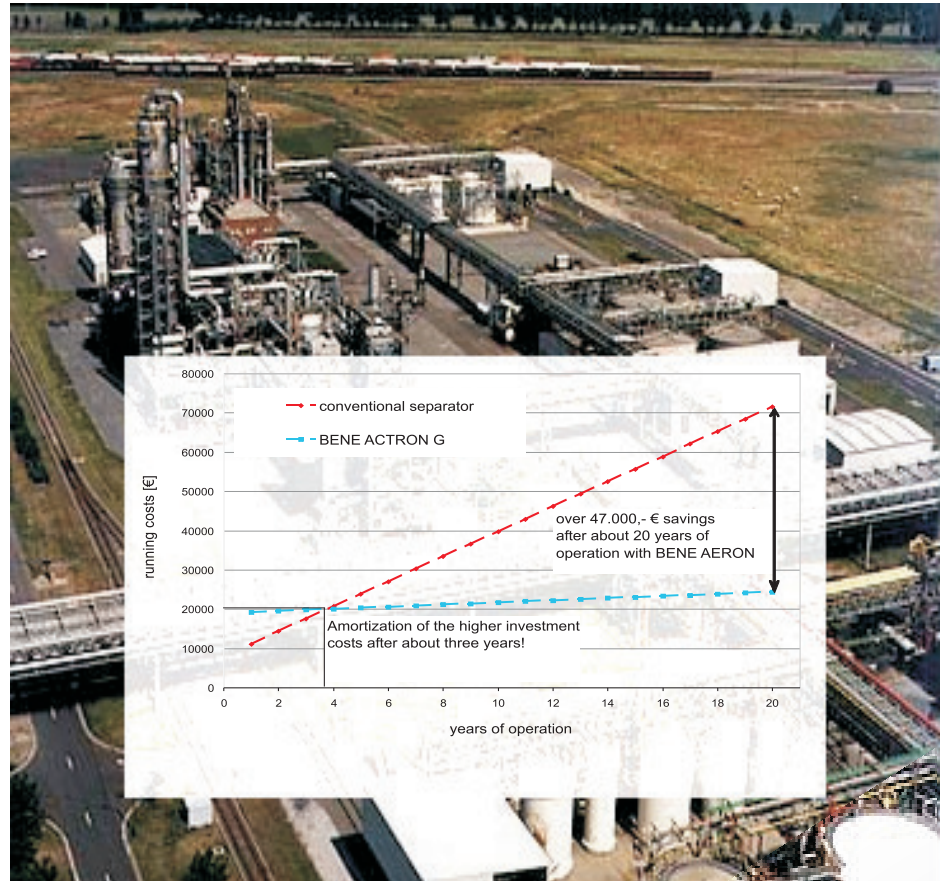

- Disposal costs: high economic efficiency thanks to disposal of sludge and oil which is apart from the separator area: disposal of oil tank content instead of disposing the total amount
- The volume / NS- quotient is extremely small

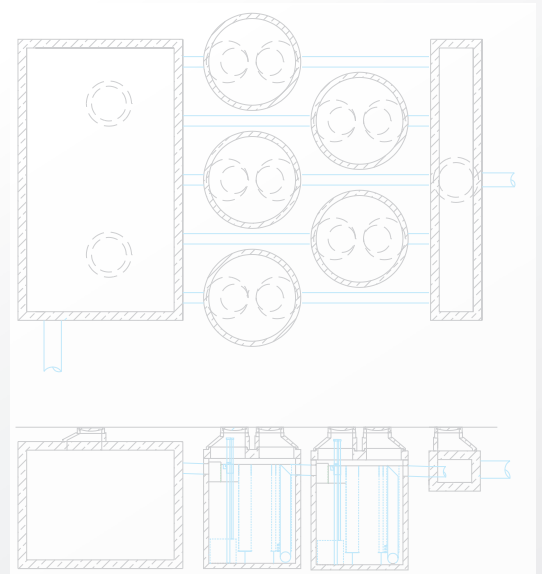
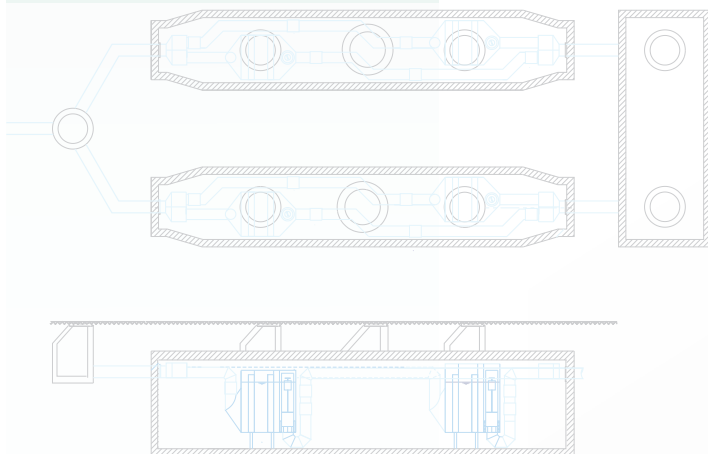

4. Environmental protection

- Closed oil tank: there is no such operation case (not even during backdraft, accumulation, high water etc.) when water could come into the tank. Just as no oil can come up during accumulation. The oil is safe in the tank!
- Protection against floating up of oil e.g. during high water
- Optimized separation of hazardous material - oil - from water → permanent oil-free separator surface because of oil drainage module
An intermediate storage is not necessary; direct outflow of oil into the oil tank
- Protection against formation of emulsions in separator thanks to permanently oil-free separator surface
- Protection against backdraft: no oil can flow out e.g. during high ground water level
- Functioning of oil separation is independent of the amount flowing through e.g. also small inflowing amount (also when <5% of the max flow amount).
- There is no danger that oil will accumulate in the flow-through separation chamber
- Optional oil accidents volume up to max. NS x 200l (e.g. NS 100: 20000l oil accident volume)
- Protection from clogging: no oil can get out in case of e.g. high ground waters



The oil films follow the hydraulic gradient and can be separated.

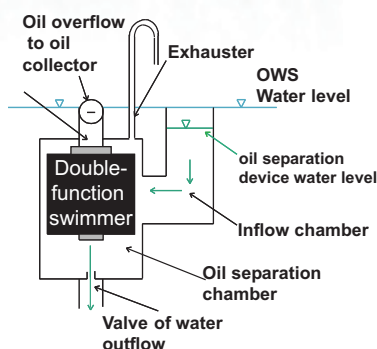

How does the oil drainage module function

- Separation and rising up of light liquids in the separator
- The light liquid flows into inflow chamber and then into swimmer chamber where it causes falling of the double function swimmer
- The light liquid is as next hydrostatically led from out of the swimmer chamber through the overflow piping into the closed oil tank
- Coming in water leads to raising of the double function swimmer
- The light liquid stays in the closed oil tank which is protected from entering of water and outflowing of oil thanks to the double function swimmer
- Through the disposal piping pure oil can be taken out of the oil tank at a very low cost. Water stays in the separator
- **The described function has been tested by an independent and neutral authority with experts on separation technology**

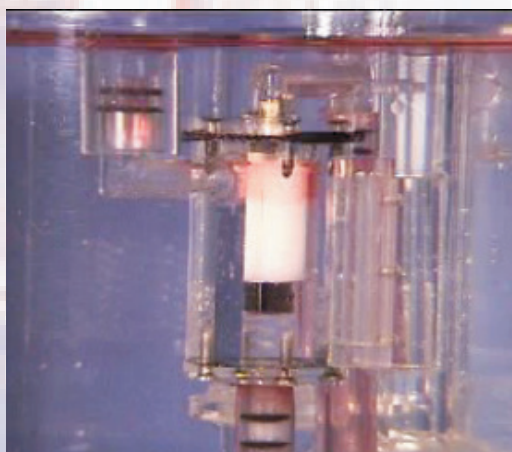

1. Easiness of maintenance

- Excellent accessibility for control, disposal and maintenance - a lot of space for maintenance personnel

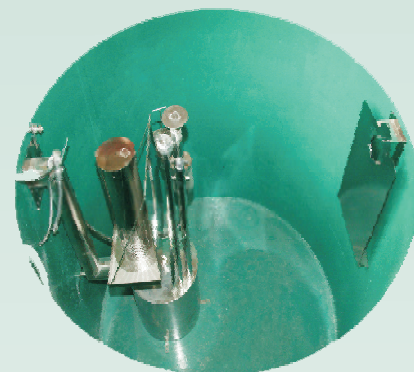

Picture shows an example of separator: DIBt Z-54.8-350

2. Technical robustness

- Angle of pipes of inflow and outflow 180° (channel in straight line, special transfer of the draining pipe and additional manholes are not necessary),
- Not prone to settling (purification and other relevant functions stay intact even in case of bevel position of tank after settling)

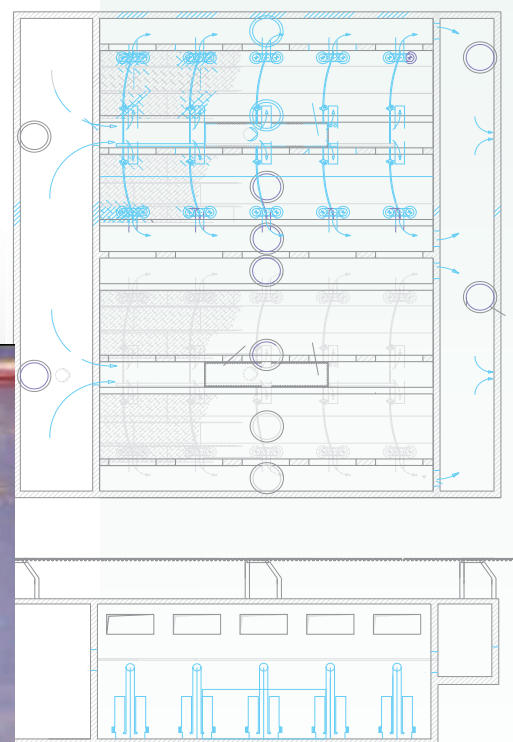

Optionally additional products for innovations in the European Standard DIN EN 858:

Innovations in the EN 858 require the installation of additional plant components:

1. The discharge of oily waste water into waters requires in particular cases an additional treatment; the additional emulsion treatment stage (ETS)

2. Basically separation plants have to be equipped with automatic warning device

**1. The additional ETS:
BENE DEMULGON**

An additional ETS is required:

- in general in case of direct discharge into waters and
- under particular chemical, physical, mechanical conditions in case of indirect inflow

Requirement according to European Standard EN 858.

We recommend as first step the high performance plant BENE ACTRON G for separation of free hydrocarbons from water. Following step is feeding the water purified of free hydrocarbons into physical emulsion plant BENE DEMULGON for separation of emulsions.

Advantages of BENE DEMULGON

- Little usage of auxiliary agent
- Low operational costs
- Smallest maintenance effort
- Minimum of hazardous waste
- Easiest handling
- Separation of emulsions and absorption of leftover free hydrocarbons

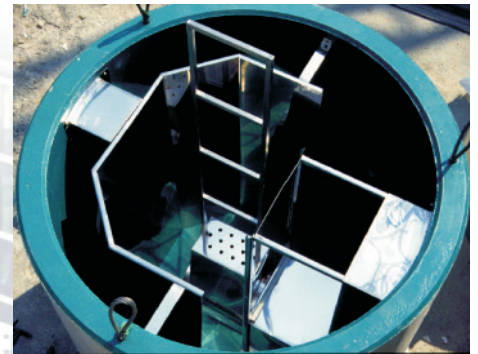

1. The net-independent warning device: BENE DETECTON

According to the new European Standard EN 858 all separation plants need a warning device, no matter what case of application, what manufacturer and what system. Existing plants without warning device have to be retrofitted.

Advantages of BENE DETECTON

- Availability of current is not necessary
- Phone network is not necessary
- Immediate sending of sms; can be set variably
- Very short installation time
- Very low costs of maintenance and operation

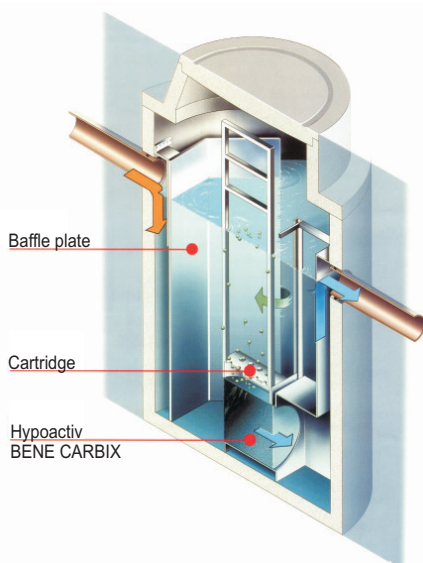

BENE ACTRON G: Additional information

Application-oriented separation technology

Our customer center with engineer and technique department leaves all possibilities of your planning open and works together with you on the best separation configuration for your particular demand.

We will be glad to send you further details about BENE ACTRON G, its plant components or other separation systems. Or if you wish we can set an appointment on the site for an unbinding consultation.

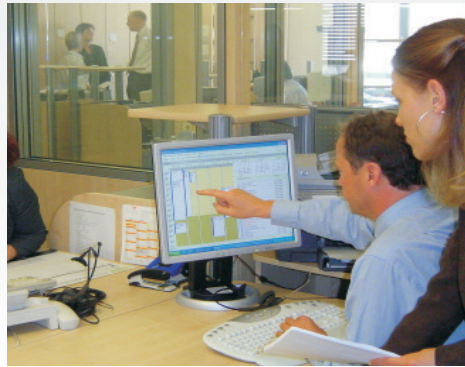

BENE - quality of the product

We use high-class materials for our products. The manufacturing of our high-quality BENE separators is secured by a team of competent and experienced engineers.



BENE ACTRON G Function modules in BENE production site

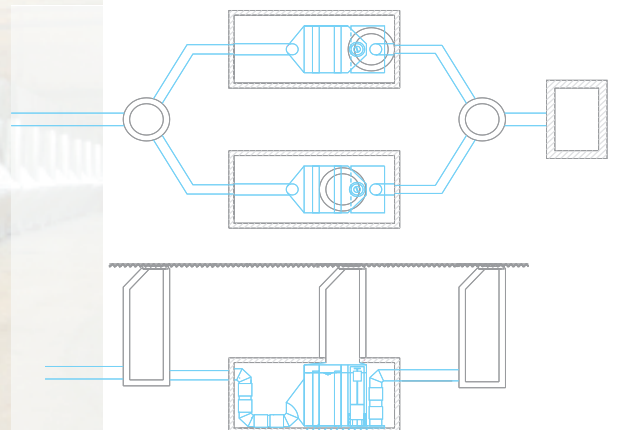
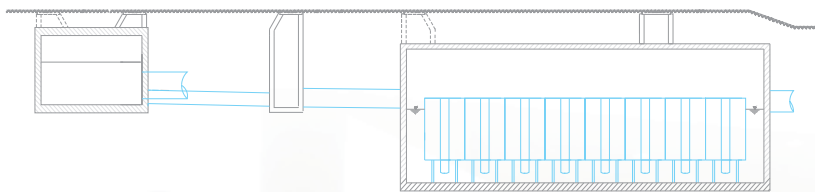
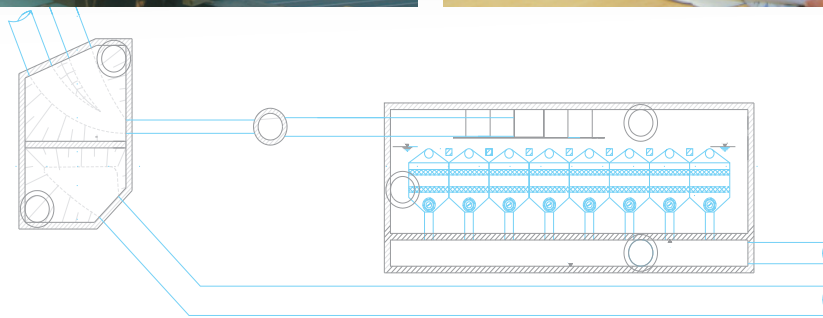

BENE ACTRON G: Chart and references

Chart BENE ACTRON G

Nominal size NG	Sludge trap volume according to EN 858			Storage volume integrated oil tank		safety oil storage on the surface	oil accident volume up to ...
	A	B	C	D	E		
60	6000	12000	18000	310	500	1050	12000
100	10000	20000	30000	517	500	1050	20000
120	12000	24000	36000	620	1000	2100	24000
180	18000	36000	54000	930	1500	3150	36000
200	20000	40000	60000	1033	1000	2100	40000
240	24000	48000	72000	1240	2000	4200	48000
300	30000	60000	90000	1550	1500	5250	60000
360	36000	72000	108000	1860	3000	6300	72000
400	40000	80000	120000	2067	2000	3150	80000
420	42000	84000	126000	2170	3500	7350	84000
480	48000	96000	144000	2480	4000	8400	96000
500	50000	100000	150000	2583	2500	4200	100000
540	54000	108000	162000	2790	4500	9450	108000
600	60000	120000	180000	3100	3000	10500	120000
660	66000	132000	198000	3410	5500	11550	132000
700	70000	140000	210000	3617	3500	7350	140000
720	72000	144000	216000	3720	6000	12600	144000
780	78000	156000	234000	4030	6500	13650	156000
800	80000	160000	240000	4133	4000	8400	160000
840	84000	168000	252000	4340	7000	14700	168000
900	90000	180000	270000	4650	4500	15750	180000
960	96000	192000	288000	4960	8000	16800	192000
1000	100000	200000	300000	5167	5000	10500	200000

You can get a detailed information concerning dimensioning in our customer center, department engineer technology.

You can also download text for bids, calculation program or technical data sheet at www.bene.de and www.bene-separa.com or get them in BENE customer center.

References / Internationality

Customers and engineering enterprises from the following countries bet on the proved and innovative BENE products and achievements:

- Afghanistan
- Australia
- Bosnia
- Bulgaria
- China
- Germany
- France
- Iran
- Iraq
- Italy
- Canada
- Luxembourg
- Malaysia
- Mexico
- Netherlands
- Philippines
- Poland
- Portugal
- Russia
- Slovenia
- Spain
- USA



BENE Technologies are applied among others in the following big areas:

- motorway underpasses
- endangered traffic areas
- chemistry enterprises
- heavy industry
- production areas
- endangered park areas
- traffic and production areas
- water protection areas
- harbor areas
- scrap metal utilisation enterprises

BENE products are applied in many industry and park areas. Here some examples:

- BP
 - Bundeswehr properties
 - BMW- locations
 - Bosch- branch offices
 - Daimler Chrysler locations
 - Deutsche Bahn logistic areas
 - Logistic centers
 - Lidl
 - LUK production sites
 - MAN company location
 - Mannesmann
 - Shell
 - Water park Güstrow
 - Stiefvater Essen
 - Volkswagen
 - US- Army
 - US- Airforce
- ...and many more areas of industry and public enterprises

You can inquire of us branch-related reference addresses.